



LYNN CARTER MFG.
 8767 Parthenia Place
 SEPULVEDA, CAL. 91343
 (213) 894-8530 • 894-4583

CUSTOMER'S INSTRUCTION SHEET

SETTING UP YOUR CARTER SHADE

1 Loosen the two screw clamps and remove the wrench. Pull outward on the uprights. The awning should unroll easily, without using the wrench. If the awning does not unroll easily, loosen the brass half clamp.



2 Insert the end rafter bars. The top of the rafter bar fits into the throat (not under) the awning rail. Push down on the uprights to make the awning taut so the rafter bars will be easier to insert.

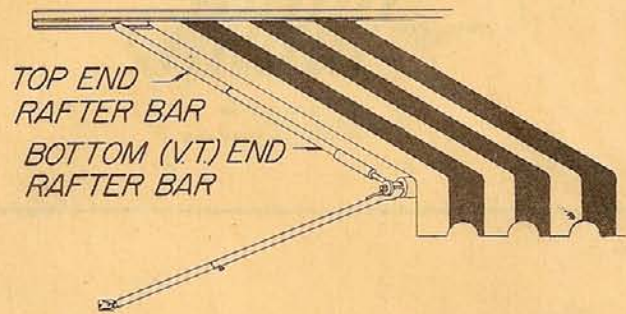

3 Assemble the two halves of the center rafter bar. The thumbscrew fits into the nut on the

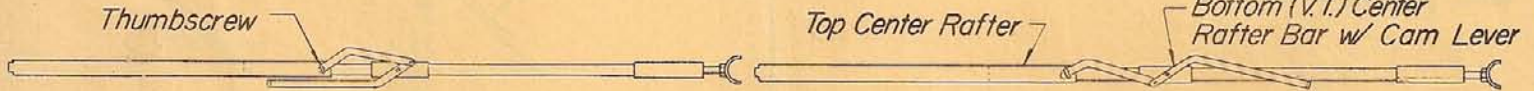

end of the top center rafter bar to form a pivot point for the extension level.

Install the center rafter bar in this position:

Then, extend the rafter to this position:

4 Move the uprights to a standing position. Keep at least an 18 inch pitch on the awning or have one end of the awning at least 10 inches lower than the other to provide adequate drainage in case of a cloudburst. Do not worry if the door rubs on the awning. The protective plastic molding will prevent any damage. Install the center upright so that it supports its share of the weight.

5 In windy areas, anchor the uprights with the spikes provided. They will hold best if you drive them in at an angle instead of straight into the ground. If you are in very sandy soil, use augers to secure the uprights to the ground. Be sure to tighten all of the thumbscrews on the uprights.

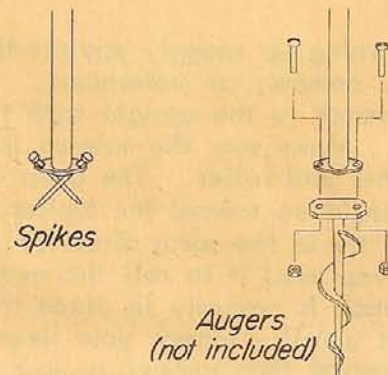
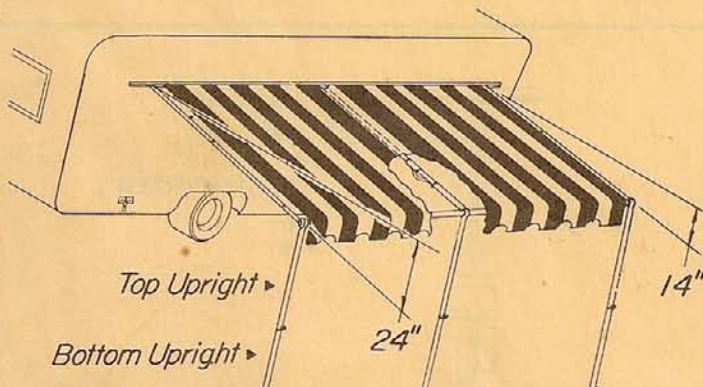

Be sure to ask your dealer for your Carter Shade Guarantee Certificate. Fill it out and send it in.

Compass Model No J R G 1-01-00-1 A A

Serial No. 68 A 11079

52712 CW 8

Model No.

00193

Serial No.

H6693

Part No.

10 Thos. 874

B-M 274
15
3

TO ROLL UP YOUR CARTER SHADE

1 Remove the center upright. Place the end uprights on the hanger brackets. Secure the uprights to the hanger brackets with the safety thumbscrew. Remove all of the rafter bars.

2 Use the ratchet wrench to roll the awning up. Adjust the 5/16th inch nut so that the half clamps are just tight enough to keep the awning from rolling down under its own weight as you are rolling it up. If the brass half clamps are too tight, the awning will be hard to unroll.

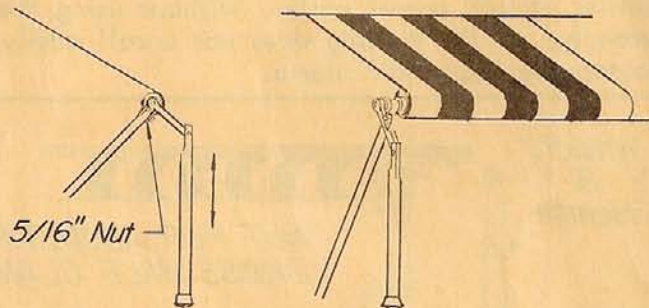
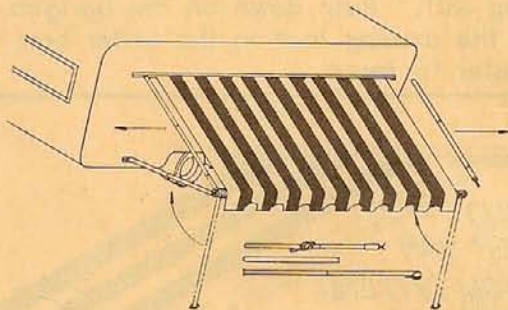

3 Watch the edge of the awning as you are rolling it up. If the end of the awning you are rolling from is going up faster than the other end, put more downward pressure on the upright with your left hand.

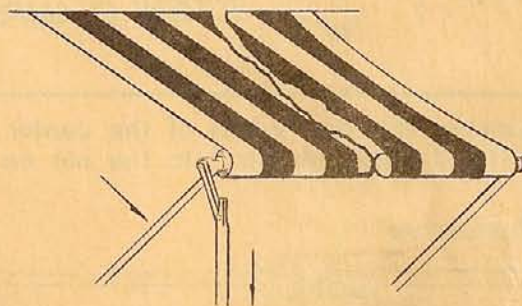

If the far end is rolling up faster than the end you are rolling from, hold the upright more toward the trailer with your left hand. Allow the edge of the awning near you to droop a little. This will effectively make the far end of the awning roll tighter.

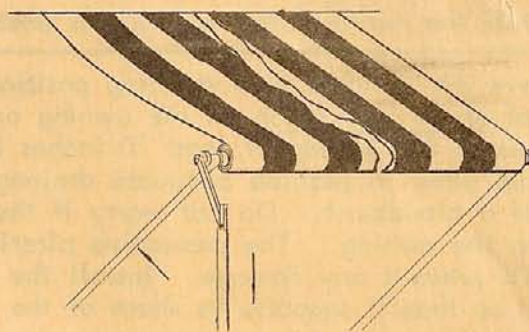

4 Roll the awning up snugly against the side of the trailer, camper, or motorhome. Secure the ratchet wrench to the upright with two screw clamps. Make sure the wrench is on the hex head of the end roller. The open side of the wrench should be toward the trailer. The wrench should be in the same direction that it was in when you used it to roll the awning up. When the wrench is properly in place the awning cannot unroll. Check your wrench and hanger bracket thumbscrews as part of your routine mechanical checkout before you start to travel.

